

Standard automatic switch 180° 2.20 m
Art.-No.: AS..1280..

Operating instructions

1 Safety instructions

Electrical equipment may only be installed and fitted by electrically skilled persons.

Failure to observe the instructions may cause damage to the device and result in fire and other hazards.

Danger of electric shock. Always disconnect before carrying out work on the device or load. At the same time, take into account all circuit breakers that supply dangerous voltage to the device or load.

Danger of electric shock. Device is not suitable for disconnection from supply voltage. The load is not electrically isolated from the mains even when the device is switched off.

Do not press on the sensor window. Device can be damaged.

Disconnect before mounting the cover, malfunction possible.

The device is not suitable for use as a burglar alarm or other alarm.

These instructions are an integral part of the product, and must remain with the end customer.

2 Device components

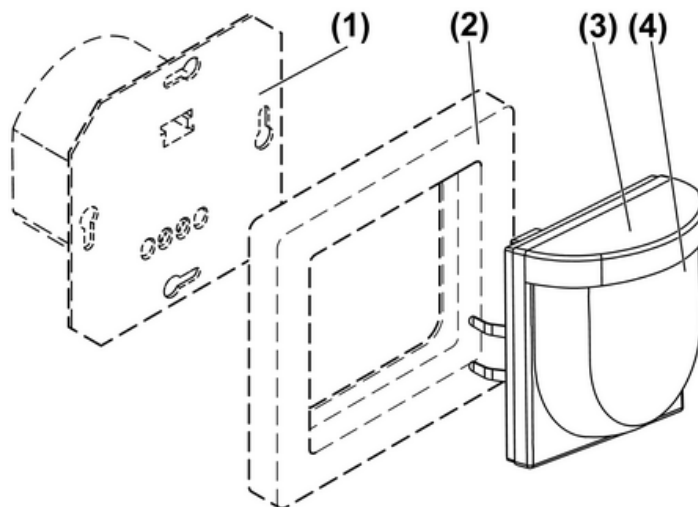

Figure 1

- (1) Insert
- (2) Frame
- (3) Motion detector
- (4) Lens

3 Function

Intended use

- Automatic switching of light, depending on heat motion and ambient brightness
- Operation with concealed insert for dimming, switching or extension insert, 3-wire
- Indoor mounting on concealed insert

Product characteristics

- Extension of the detection area in combination with the 3-wire extension insert
- Operation with 2-wire extension or installation button
- Teach function for adjustment of the brightness threshold
- Switch-on brightness permanently storable, with dimming insert
- Light dimmable, with dimming insert and connected 2-wire extension insert
- Creep zone protection
- Run-on time limit

 Sensitivity and run-on time cannot be changed.

Automatic operation

The motion detector detects heat motions of people, animals and objects.

- The light is switched on when the detection area is entered and the brightness threshold is exceeded.
The run-on time restarts with each detected motion.
- The light is switched off if no motion is detected in the detection area and the run-on time has elapsed or the run-on time limit is reached.

To avoid any light swings caused by a cooling illuminant, the motion detector does not evaluate any motion signals for a brief lockout time after switching off. The motion detector adjusts itself to the ambient conditions to keep the time as short as possible.

The day/night switchover takes place after a delay of 30 seconds. Switching over is thus prevented by briefly illuminating or shadowing to the day/night operation.

Run-on time limit

The light is switched off after 90 minutes at the latest even if there is constant motion in the detection area. The light is only switched on again if the brightness drops below the threshold and motions are detected.

Behaviour after a mains failure

- Less than 0.2 seconds: The old switching position is restored after mains return.
- 0.2 seconds until approx. 2 seconds: The light is switched on for the run-on time after mains return.
- Longer than 2 seconds: The motion detector goes through a self-test for approx. 40 seconds after mains return. The light is first switched on. After approx. 10 seconds, the light is switched off. After the end of the self-test, the light is switched on for the duration of the run-on time.

4 Operation

Switching on light for the duration of the run-on time

A 2-wire extension or an installation button is connected.

- Press 2-wire extension or installation button for less than 0.4 seconds.

Light is switched on depending on brightness and motion. Motions are evaluated further and prolong the run-on time.

 If the motion detector is combined with a dimmer insert, the light is always switched on to the saved switch-on brightness

 The light cannot be switched off manually.

Adjust the brightness

Motion detector is combined with a dimming insert.

The light can be dimmed temporarily. The next time the light is switched on, it is switched on again to the switch-on brightness

A 2-wire extension is connected.

Light is switched on.

- 2-wire extension above, press for longer than 0.4 seconds.
The light gets brighter up to maximum brightness.
- 2-wire extension below, press for longer than 0.4 seconds.

Light gets darker to minimum brightness.

- i** An installation button cannot be used to adjust the brightness.

Switching the light on with minimum brightness

Motion detector is combined with a dimming insert.

A 2-wire extension is connected.

Light is off.

- 2-wire extension below, press for longer than 0.4 seconds.
The light is switched on to minimum brightness for the duration of the run-on time.

- i** An installation button cannot be used to switch on to minimum brightness.
- i** If the 2-wire extension above is pressed for longer than 0.4 seconds, the light is switched on to minimum brightness and then brighter.

Save switch-on brightness

Motion detector is combined with a dimming insert.

A 2-wire extension is connected.

Light is on.

- Set light to the required brightness.
- 2-wire extension insert over entire surface, press for longer than 3 seconds.
Switch-on brightness is saved.
For confirmation, the light is switched off briefly and switched on again.

- i** In the state as supplied the maximum switch-on brightness is saved.
- i** An installation button cannot be used to save the switch-on brightness.

Changing the brightness threshold

The ambient brightness can be permanently saved as brightness threshold with the aid of the teach function. As-delivered state approx. 10 Lux.

- i** Do not shadow the motion detector during the measuring process.
- i** In combination with the automatic RMD stairway light: set the shortest run-on time on the RMD stairway light.
- i** If there is low ambient brightness, the motion detector has difficulty detecting the changes in light, which are required to activate the teach function. Recommendation: During activation, provide additional illumination of the motion detector, e.g. with a flashlight.

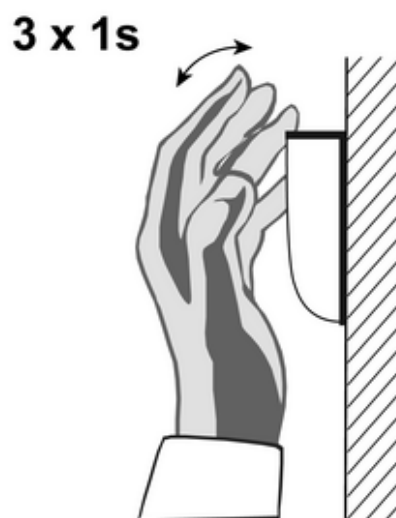

Figure 2

- Cover the motion detector with your hand for approx. 1 second at least three times within 9 seconds (figure 2).
 The teach function is activated after three light changes have been detected. For confirmation, the switched on light is switched off. If the light is switched off, this is switched on for approx. 1 second.
 After 30 seconds, the motion detector measures the brightness and saves it. For confirmation, the light is switched on for the duration of the run-on time.
- ⓘ If a value greater than 200 lux is saved, the motion detector switches to day operation independent of the brightness.

5 Information for electrically skilled persons

5.1 Fitting and electrical connection



DANGER!

Electrical shock when live parts are touched.

Electrical shocks can be fatal.

Before carrying out work on the device or load, disengage all the corresponding circuit breakers. Cover up live parts in the working environment.

Selecting the installation location

When choosing the installation location, the following points must be considered.

- Select a vibration-free installation location. Vibrations can lead to unwanted switching.
- Avoid interference sources in the detection area. Interference sources such as heaters, fans, air-conditioners and cooling illuminants can lead to unwanted switching.

Motions crosswise to the motion detector (figure 3) B can be detected more easily than motions approaching the motion detector (figure 3) A. Thus, the cross walking range is greater than the walk to walking range.

- Take direction of motion into account.

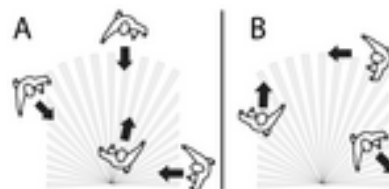

Figure 3

All information regarding the range (figure 4) applies to an installation height of 2.2 m. In the case of a deviating installation height, the range changes (figure 5).

- Determine installation height.

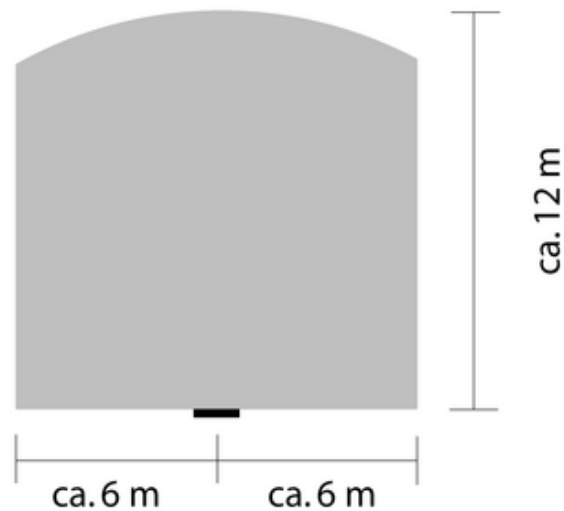

Figure 4

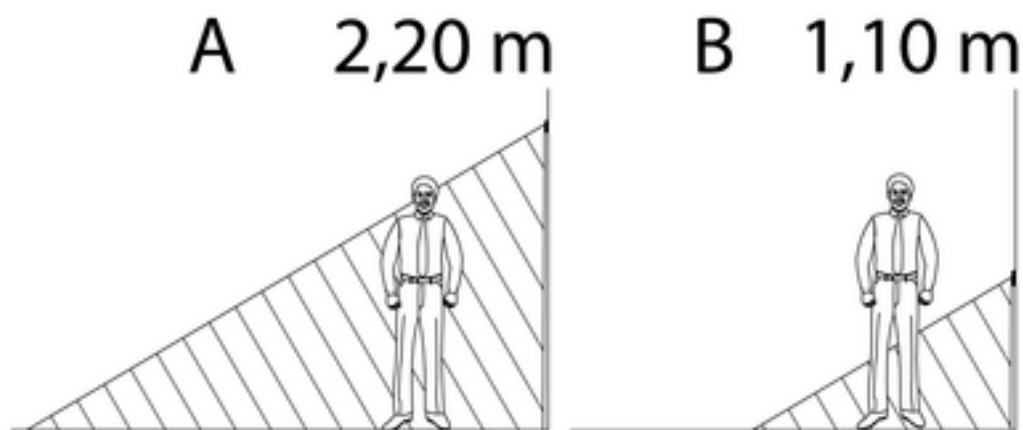

Figure 5

Installing the motion detector

The concealed insert is connected and installed correctly (see Concealed insert instructions).

- i** Further installation steps are necessary to ensure the protection rating IP 44 (see Seal set instructions)
 - Mount the motion detector with the frame onto onto concealed insert.

Expanding the detection area

To expand the detection area, connect a 3-wire extension insert with motion detector cover. The motion detector of the main unit also evaluates motion signals of the extension and, if necessary, switches the lighting on.

The concealed insert is connected and installed correctly (see Concealed insert instructions).

- Mount the motion detector with the frame onto the concealed insert.
- i** Do not connect any main units in parallel. This can lead to light swings

5.2 Commissioning

Configuring the motion detector

Only when the brightness drops below the threshold will the light be switched on when there is motion in the detection area.

- Adjust optional brightness threshold with teach function (see chapter 4. Operation).

i Sensitivity and run-on time cannot be changed.

Checking the detection area

- Pace off the detection area, paying attention to reliable detection and interference sources.

i Adjust any previous, possible brightness threshold or darken the room.

6 Appendix

6.1 Technical data

Ambient temperature	-15 ... +45 °C
Protection rating	IP 20
Brightness setting	approx. 1 ... 200 lx (and day operation)
run-on time	approx. 2 min
Lockout time	approx. 0.3 ... 4 s
Installation height	1.10 / 2.20 m
Detection angle	180 °
cross walking range	approx. 12 x 6 m
walk to walking range	approx. 8x4 m

6.2 Troubleshooting

Motion detector does not switch on

Cause 1: The ambient brightness is greater than the adjusted brightness threshold.

Adjust brightness value using teach function (see chapter 4. Operation).

Cause 2: Motion detector does not detect any motions.

Check detection area for any obstacles.

Motion detector switches on without motion.

Cause: Motion detector detects heat motions.

Pay attention to interference sources such as heaters, fans, air-conditioners and cooling illuminants in the detection area.

Motion detector switches off despite motion

Cause 1: Run-on time limit is reached. The run-on time is limited to a maximum of 90 minutes.

Cause 2: Motion detector is switched off on 3-wire extension insert.

Switch on motion detector.

Motion detector does not switch off after the set follow-up time has elapsed

Cause: Motion detector detects motions constantly.

Pay attention to interference sources such as heaters, fans and air-conditioners in the detection area.

6.3 Accessories

Sealing kit for automatic switch 180° 2.20 m

Art.-No.: AS 50 DS

6.4 Warranty

We reserve the right to make technical and formal changes to the product in the interest of technical progress.

We provide a warranty as provided for by law.

Please send the unit postage-free with a description of the defect to our central customer service office:

ALBRECHT JUNG GMBH & CO. KG

Service Center
Kupferstr. 17-19
D-44532 Lünen
Service-Line: +49 (0) 23 55 . 80 65 51
Telefax: +49 (0) 23 55 . 80 61 89
kundencenter@jung.de

General equipment

Service-Line: +49 (0) 23 55 . 80 65 55
Telefax: +49 (0) 23 55 . 80 62 55
kundencenter@jung.de

KNX equipment

Service-Line: +49 (0) 23 55 . 80 65 56
Telefax: +49 (0) 23 55 . 80 62 55
kundencenter@jung.de

The € symbol is a free trade symbol, which is solely intended for the authorities and does not guarantee any properties.

ALBRECHT JUNG GMBH & CO. KG

Volmestraße 1
D-58579 Schalksmühle

Telefon: +49.23 55.8 06-0
Telefax: +49.23 55.8 06-1 89
E-mail: mail.info@jung.de
Internet: www.jung.de
www.jung-katalog.de