



nueva serie 100 **E**

the new 100 series **ENG**

nouvelle série 100 **F**

nova série 100 **P**

nuova serie 100 **I**

neue serie 100 **D**

e2.1

- E** 2 canales de música ambiental (2 entradas para fuentes de sonido externas)
- ENG** 2 background music channels (2 inputs for external sound sources)
- F** 2 canaux de musique d'ambiance (2 entrées pour des sources de son extérieures)
- P** 2 canais de música ambiental (2 entradas para fontes de som externas)
- I** 2 canali di musica background (2 ingressi per fonti di suono esterne)
- D** 2 Kanäle Musikberieselung (2 Eingänge f. externe Tonquellen)

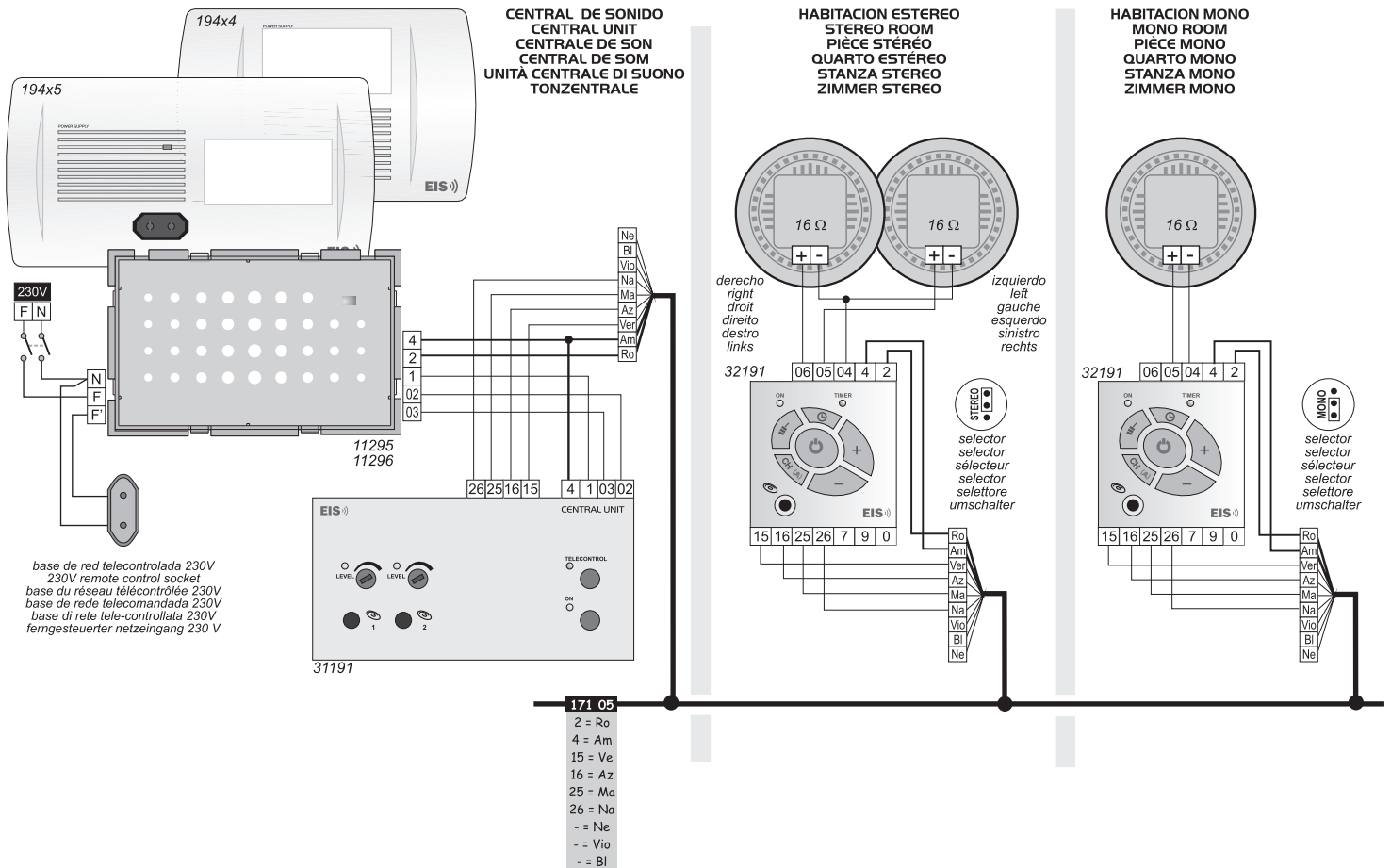

e2.2

- E** 2 canales de música ambiental (1 sintonizador FM + 1 entrada para fuentes de sonido externas)
- ENG** 2 background music channels (1 FM tuner + 1 input for external sound source)
- F** 2 canaux de musique d'ambiance (1 syntoniseur FM + 1 entrée pour des sources d'alimentation extérieures)
- P** 2 canais de música ambiental (1 sintonizador FM + 1 entrada para fontes de som externas)
- I** 2 canali di musica background (1 sintonizzatore FM + 1 ingresso per fonti di suono esterne)
- D** 2 Kanäle Musikberieselung (1 UKW-Empfänger + 1 Eingang f. externe Tonquelle)

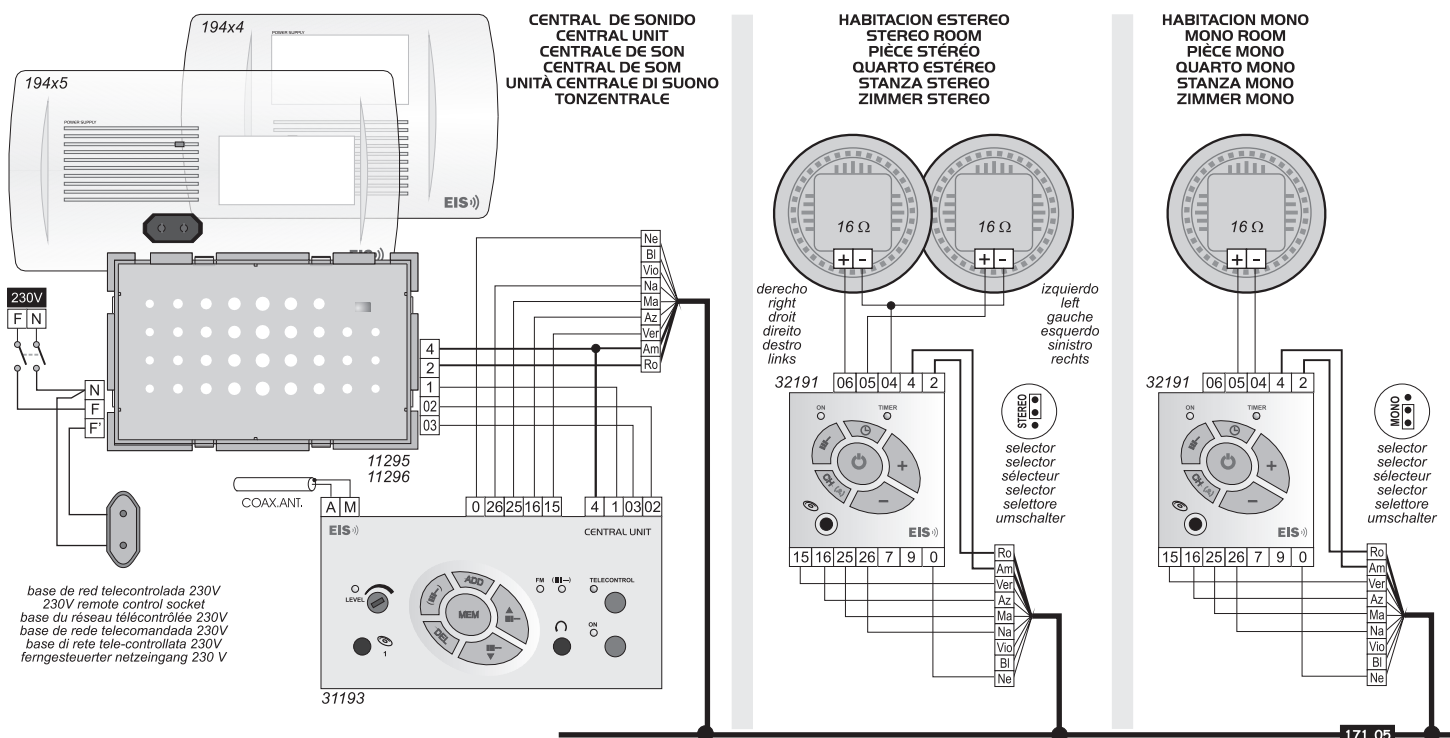

e2.3

- E** 2 canales de música ambiental con llamada general
- ENG** 2 background music channels with general intercom calling
- F** 2 canaux de musique d'ambiance avec appel général
- P** 2 canais de música ambiental com chamada geral
- I** 2 canali di musica background con chiamata generale
- D** 2 Kanäle Musikberieselung mit allgemeinem Durchruf

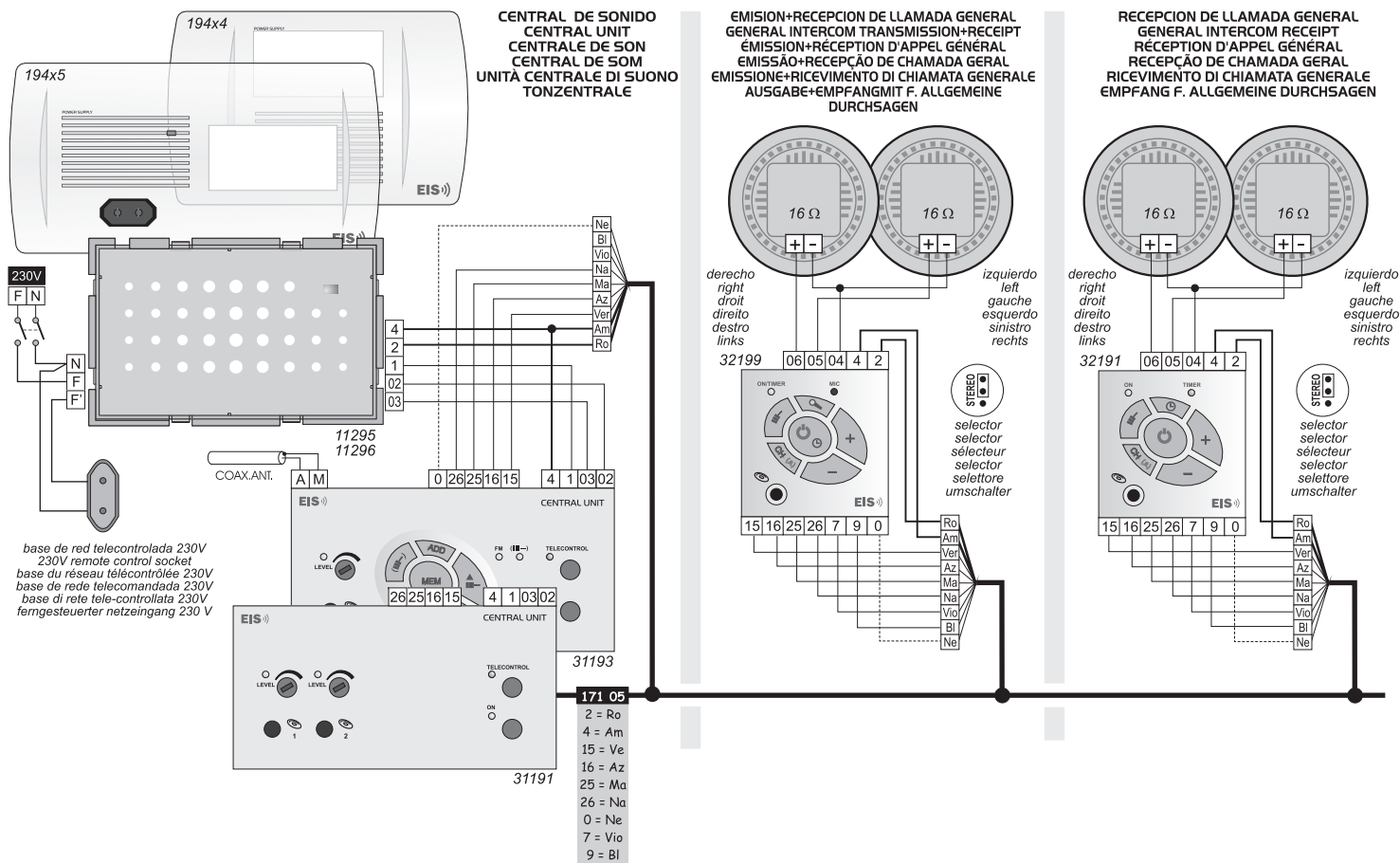

e2.4

- E** 4 canales de música ambiental
- ENG** 4 background music channels
- F** 4 canaux de musique d'ambiance
- P** 4 canais de música ambiental
- I** 4 canali di musica background
- D** 4 Kanäle Musikberieselung

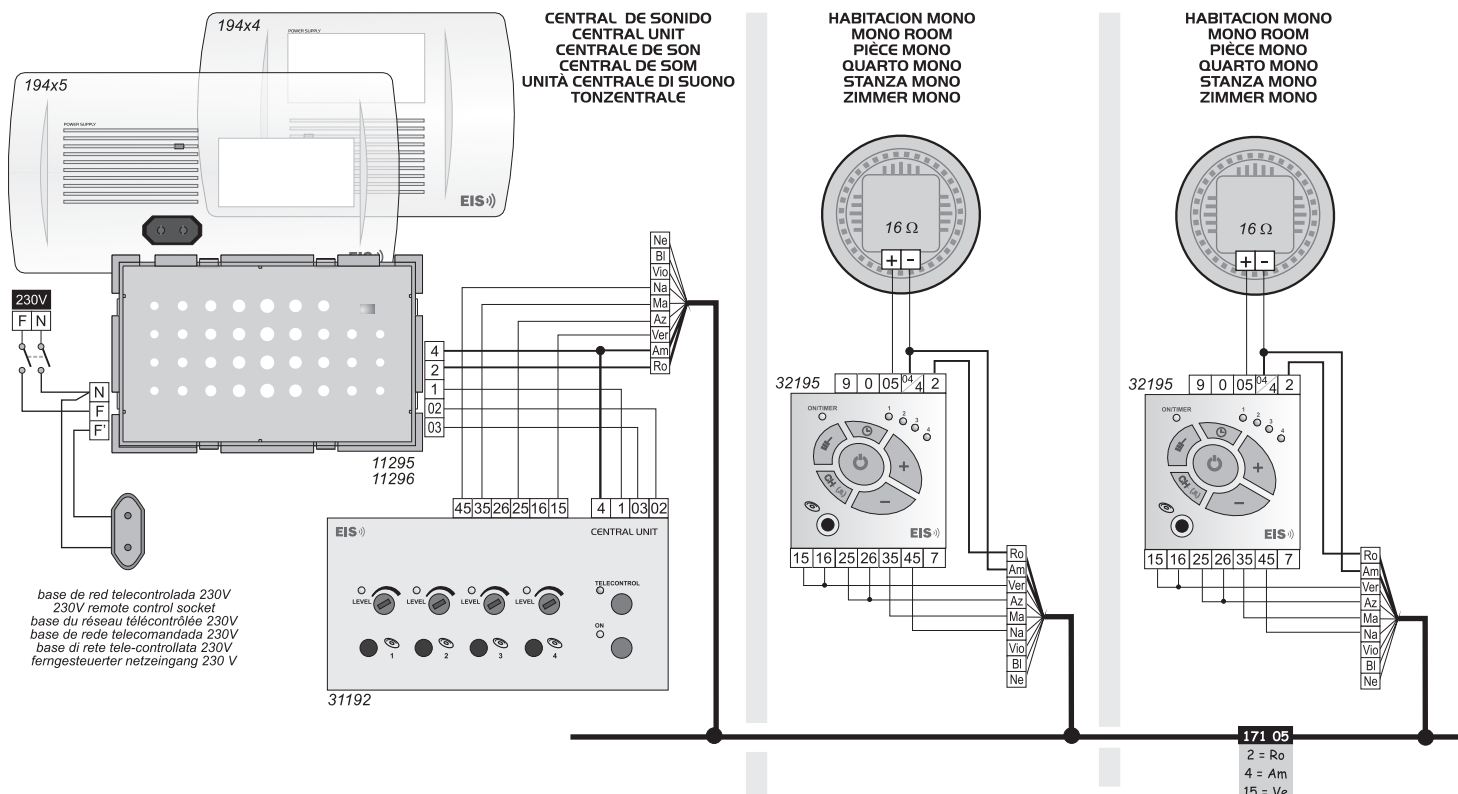

e2.5

- E** mando con sintonizador FM incorporado
- ENG** control unit with built-in FM tuner
- F** commande avec syntoniseur FM incorporé
- P** comando com sintonizador FM incorporado
- I** comando con sintonizzatore FM incorporato
- D** steuerung mit eingebautem UKW-Empfänger

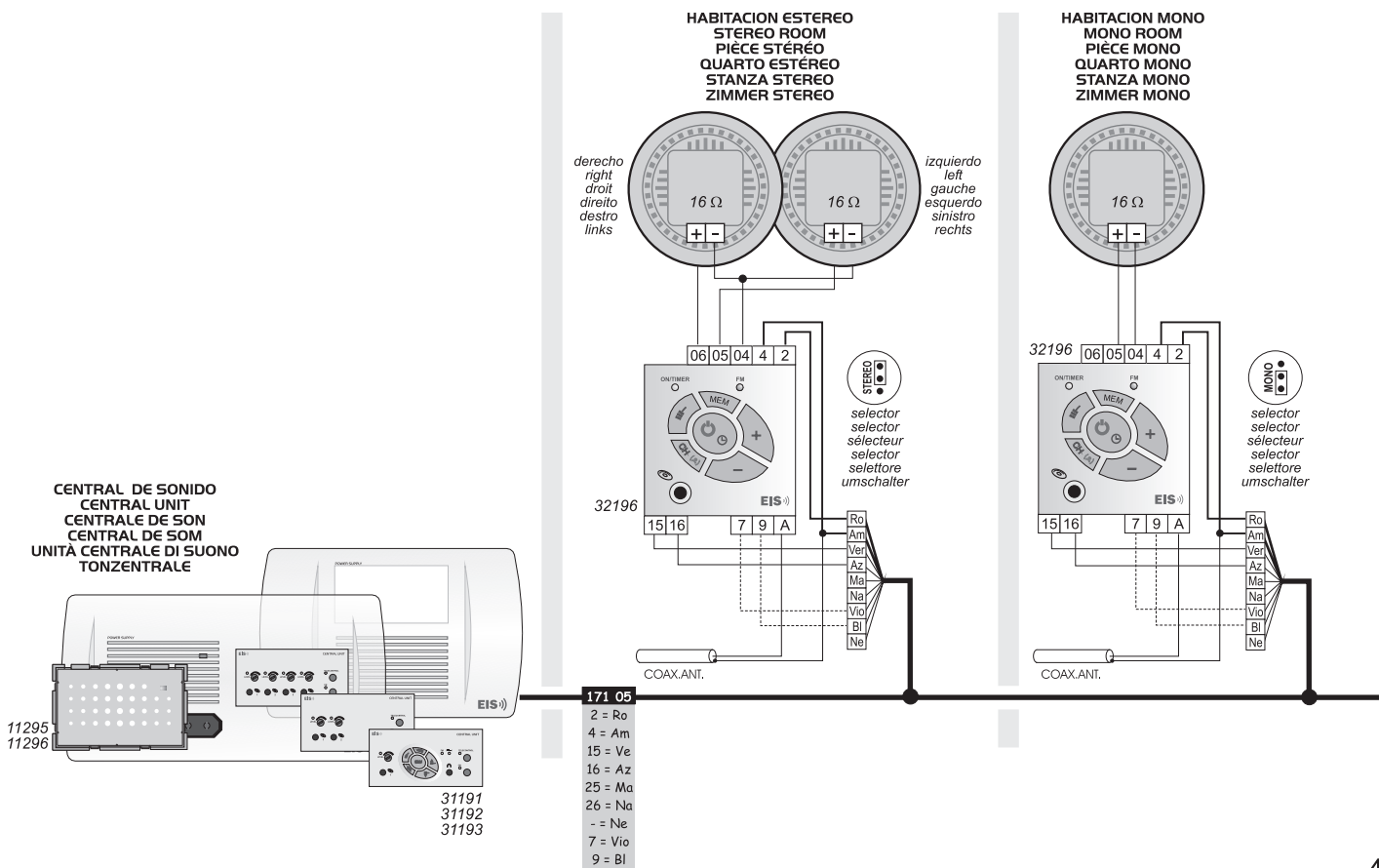

e2.6

- E** llamada general desde uno o varios pupitres
- ENG** general intercom calling from a single or several microphone bases
- F** appel général à partir d'un ou plusieurs pupitres
- P** chamada geral desde um ou várias mesas de comando
- I** chiamata generale da una o varie basi
- D** allgemeiner Durchruf von 1 bzw. mehreren Sprechstellen

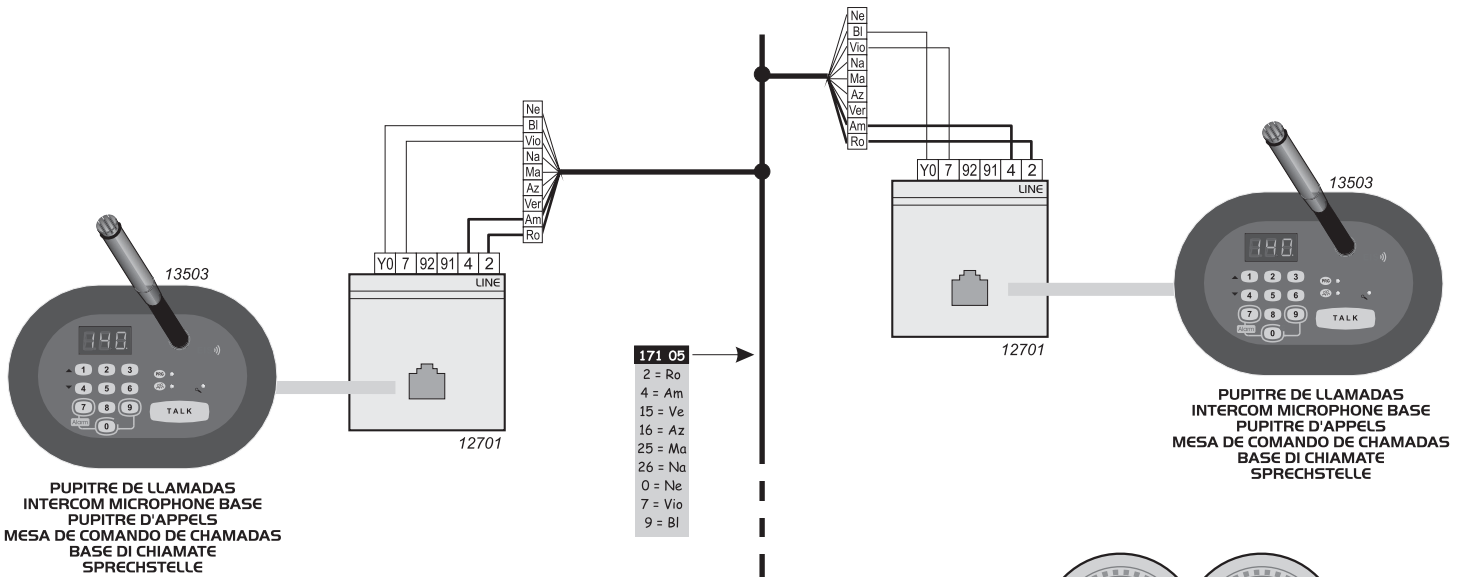

INSTALACIONES DE 2 CANALES
TWO-CHANNEL INSTALLATIONS
INSTALLATIONS AYANT 2 CANAUX
INSTALAÇÃO DE 2 CANAIS
INSTALLAZIONI DI 2 CANALI
2-KANAL-ANLAGE

PUPITRE DE LLAMADAS
INTERCOM MICROPHONE BASE
PUPITRE D'APPELS
MESA DE COMANDO DE CHAMADAS
BASE DI CHIAMATE
SPRECHSTELLE

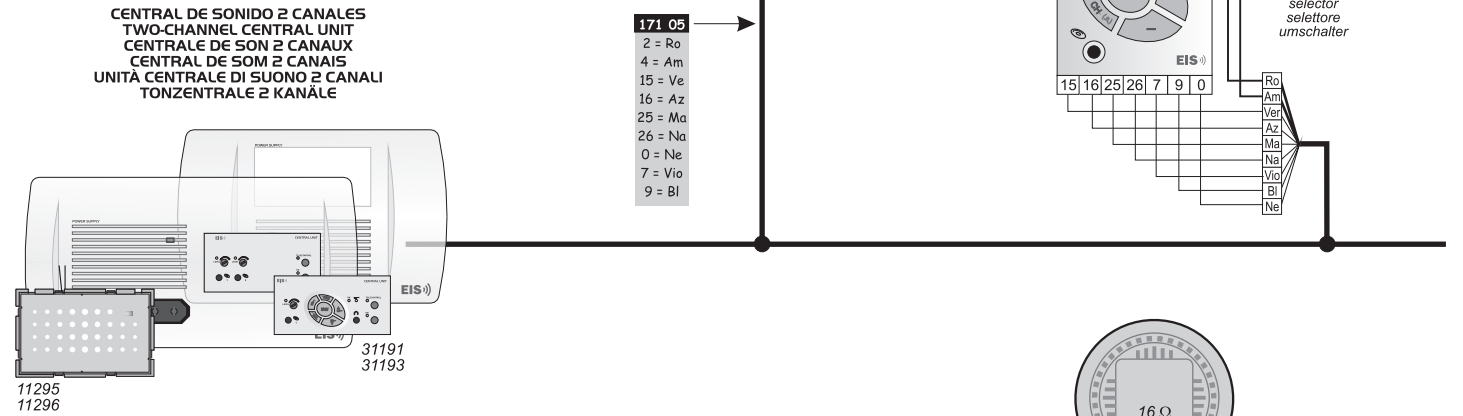

CENTRAL DE SONIDO 2 CANALES
TWO-CHANNEL CENTRAL UNIT
CENTRALE DE SON 2 CANAUX
CENTRAL DE SOM 2 CANAIS
UNITÀ CENTRALE DI SUONO 2 CANALI
TONZENTRALE 2 KANÄLE

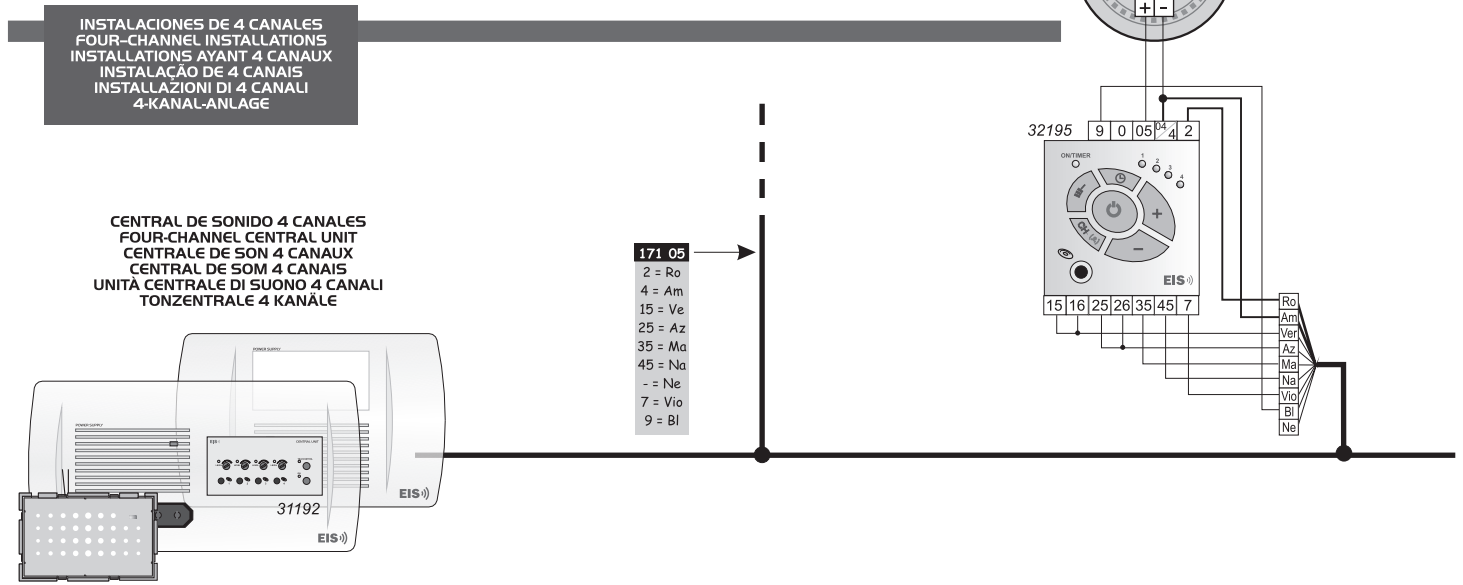
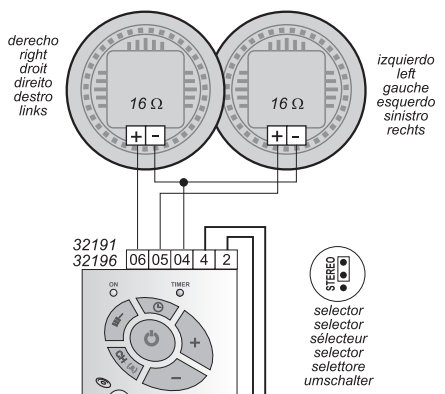

CENTRAL DE SONIDO 4 CANALES
FOUR-CHANNEL CENTRAL UNIT
CENTRALE DE SON 4 CANAUX
CENTRAL DE SOM 4 CANAIS
UNITÀ CENTRALE DI SUONO 4 CANALI
TONZENTRALE 4 KANÄLE

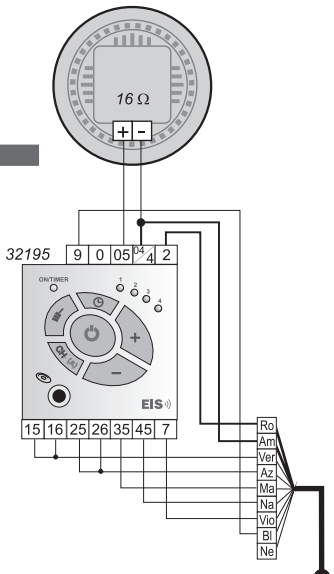

e2.7

- E** avisos por zonas desde un pupitre
- ENG** intercom calling by zones from a single microphone base
- F** annonces par zones à partir d'un pupitre
- P** avisos para zonas desde una mesa de comandos
- I** avvisi per zone da una base
- D** zonendurchsagen von einer Sprechstelle

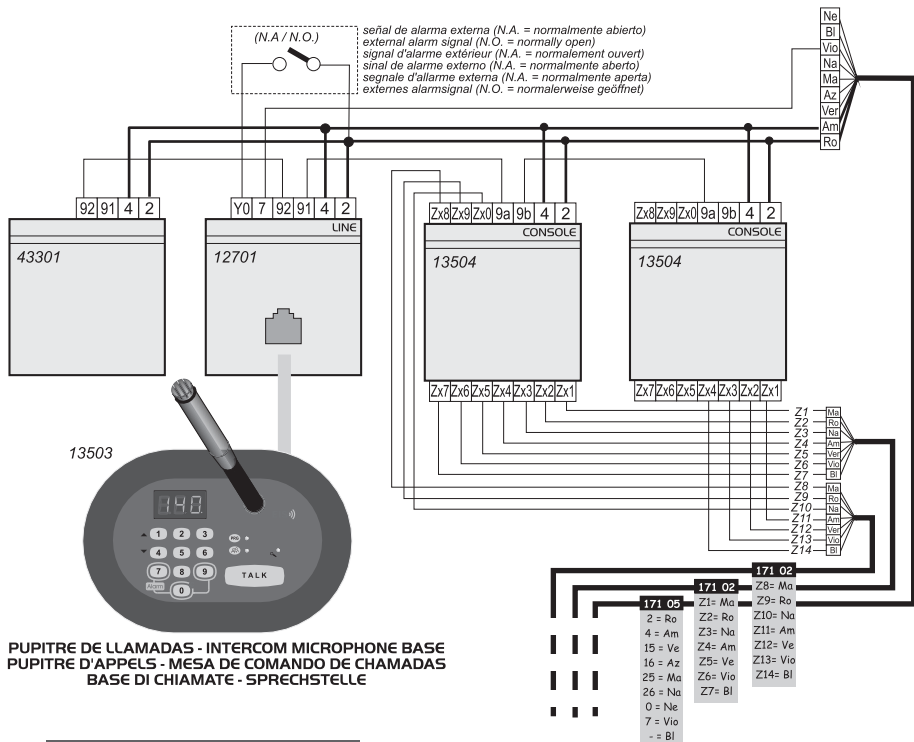

PUPITRE DE LLAMADAS - INTERCOM MICROPHONE BASE
 PUPITRE D'APPELS - MESA DE COMANDO DE CHAMADAS
 BASE DI CHIAMATE - SPRECHSTELLE

INSTALACIONES DE 2 CANALES
 TWO-CHANNEL INSTALLATIONS
 INSTALLATIONS AYANT 2 CANAUX
 INSTALAÇÃO DE 2 CANAIS
 INSTALLAZIONI DI 2 CANALI
 2-KANAL-ANLAGE

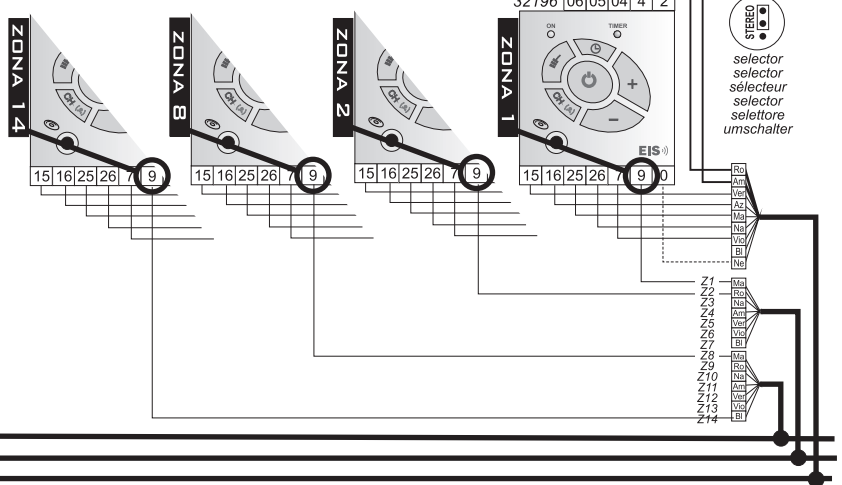
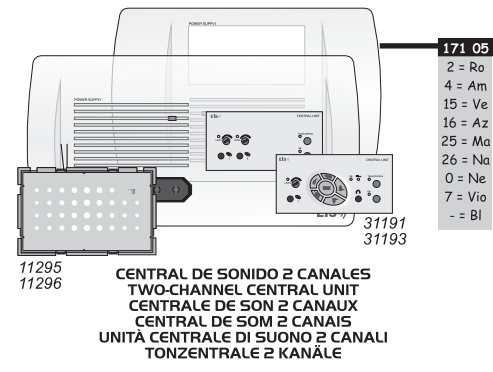
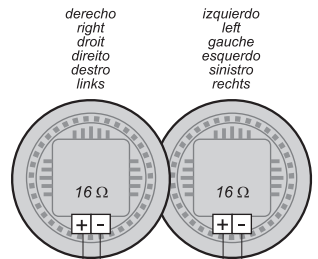

INSTALACIONES DE 4 CANALES
 FOUR-CHANNEL INSTALLATIONS
 INSTALLATIONS AYANT 4 CANAUX
 INSTALAÇÃO DE 4 CANAIS
 INSTALLAZIONI DI 4 CANALI
 4-KANAL-ANLAGE

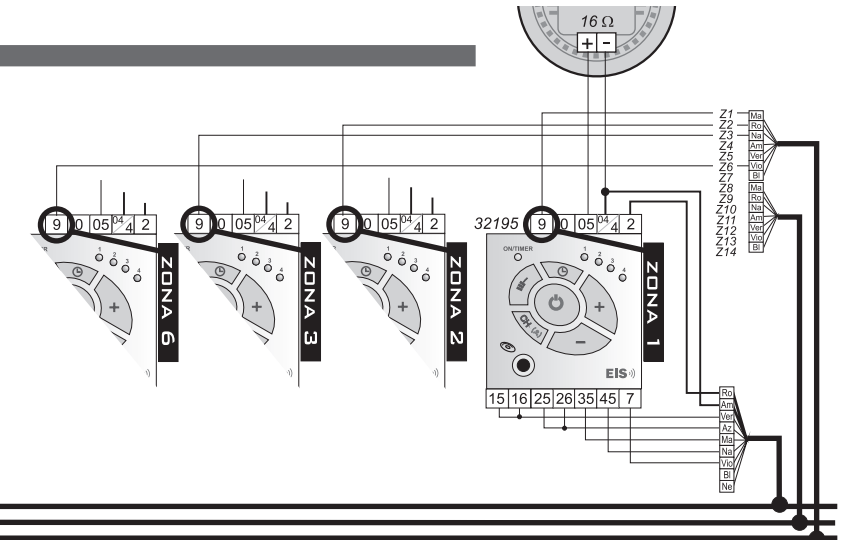
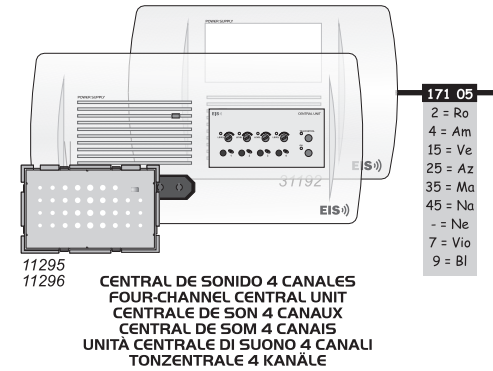

e2.8

- E** llamada general desde una centralita telefónica
- ENG** general intercom transmission from a switchboard
- F** transmission générale d'intercom depuis un standard de téléphone
- P** chamada geral a partir duma central telefónica
- I** chiamata generale da un centralino telefonico
- D** Allgemeine Wechselsprachanlage Kommunikation von eine Telefonzentrale

INSTALACIONES DE 2 CANALES TWO-CHANNEL INSTALLATIONS INSTALLATIONS AYANT 2 CANAUX INSTALAÇÃO DE 2 CANAIS INSTALLAZIONI DI 2 CANALI 2-KANAL-ANLAGE

CENTRALITA TELEFONICA
SWITCHBOARD
STANDARD DE TELEPHONE
CENTRAL TELEFÓNICA
CENTRALINO TELEFONICO
TELEFONZENTRALE

43492

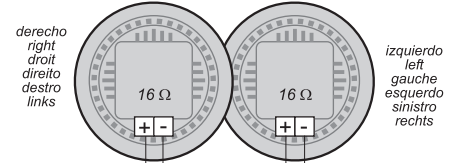
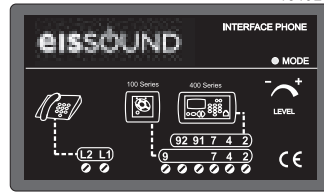

CENTRAL DE SONIDO 2 CANALES
TWO-CHANNEL CENTRAL UNIT
CENTRALE DE SON 2 CANAUX
CENTRAL DE SOM 2 CANAIS
UNITÀ CENTRALE DI SUONO 2 CANALI
TONZENTRALE 2 KANÄLE

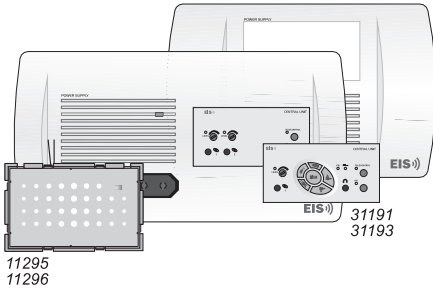

- 171 05
- 2 = Ro
 - 4 = Am
 - 15 = Ve
 - 16 = Az
 - 25 = Ma
 - 26 = Na
 - 0 = Ne
 - 7 = Vio
 - 9 = Bl

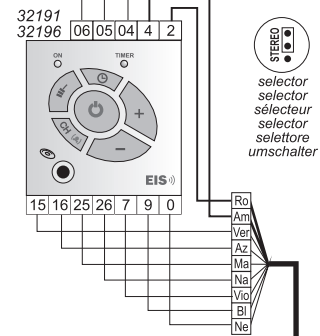

INSTALACIONES DE 4 CANALES FOUR-CHANNEL INSTALLATIONS INSTALLATIONS AYANT 4 CANAUX INSTALAÇÃO DE 4 CANAIS INSTALLAZIONI DI 4 CANALI 4-KANAL-ANLAGE

CENTRALITA TELEFONICA
SWITCHBOARD
STANDARD DE TELEPHONE
CENTRAL TELEFÓNICA
CENTRALINO TELEFONICO
TELEFONZENTRALE

43492

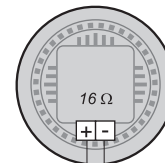
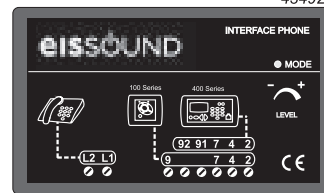

CENTRAL DE SONIDO 4 CANALES
FOUR-CHANNEL CENTRAL UNIT
CENTRALE DE SON 4 CANAUX
CENTRAL DE SOM 4 CANAIS
UNITÀ CENTRALE DI SUONO 4 CANALI
TONZENTRALE 4 KANÄLE

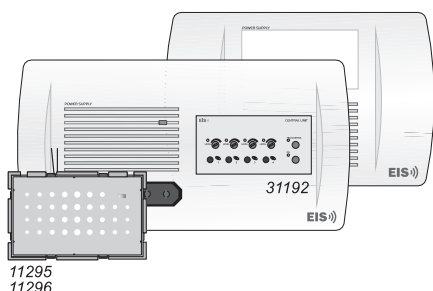

- 171 05
- 2 = Ro
 - 4 = Am
 - 15 = Ve
 - 25 = Az
 - 35 = Ma
 - 45 = Na
 - = Ne
 - 7 = Vio
 - 9 = Bl

